

Compact & Powerful Inverter **Starvert iG5A**

0.4~1.5kW 1phase 200~230Volts
0.4~22kW 3Phase 200~230Volts
0.4~22kW 3Phase 380~480Volts



Automation Equipment



Inverter STARVERT iG5A

LS Starvert iG5A is very competitive in its price and shows an upgraded functional strength. User-friendly interface, extended inverter ranges up to 22kW, superb torque competence and small size of iG5A provides an optimum use environment.



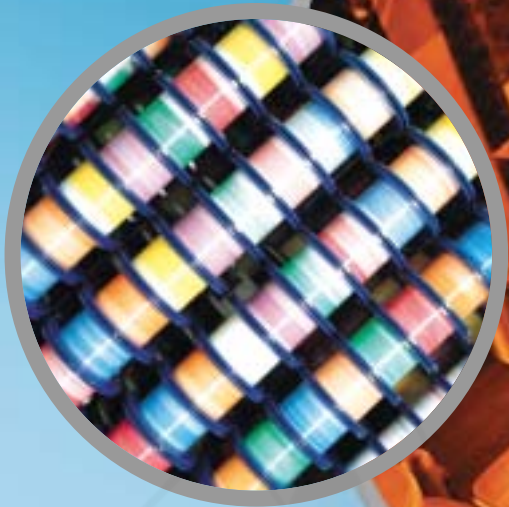

Contents

4	Overview
8	Model & Type
9	Standard Specifications
11	Wiring
13	Terminal Configurations
15	Keypad Features
16	Parameter Setting
18	Trial Run
20	Dimensions
23	Braking Resistors and Peripheral Devices
25	Function List
32	Protective Functions
33	Fault Remedy

Powerful & Upgraded Performance

iG5A provides sensorless vector control, PID control, and ground-fault protection through powerful built-in functions.

■ Sensorless vector control

The built-in sensorless vector control provides the superb speed control and powerful high torque.

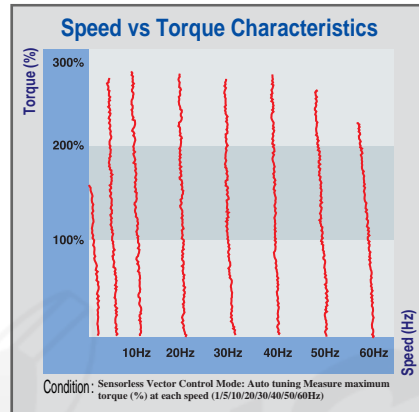

■ Ground-fault protection during running

The ground-fault protection of output terminal is possible during running.

■ Analog control from -10V to 10V

Inputting analog signals from -10V to 10V provides user-friendly operation.

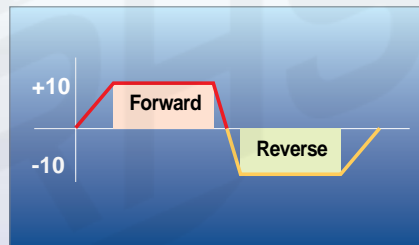

■ Built-in PID control

The built-in PID function enables to control flow-rate, oil-pressure, temperature, etc without any extra controller.

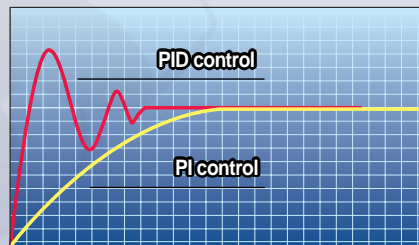

■ Built-in dynamic braking circuit

The built-in dynamic braking circuit minimizes deceleration time via braking resistors.

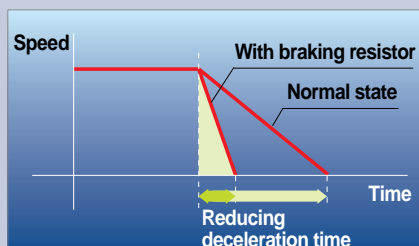

■ Built-in 485 communication

The built-in RS-485 communication supports remote control and monitoring between iG5A and other equipment.

■ Wide product range

iG5A consists of the product range from 0.4 to 22KW.





RS-485 communication

Connected to PC



RS-485 - 232C converter

■ Monitoring

- Checking operation status (Voltage, Current, Frequency, etc)
- Checking modified parameters
- Windows support

■ Remote Control

- Convenient remote control to modify operation status (Forward/Reverse operation, Frequency, etc)
- Easy parameter setting
- Available to control up to 31 Inverters
- RS-485, Modbus communication

Connected to XGT panel



■ Monitoring

- Checking operation time
- Automatic list-up of trip record
- Language support (Korean, English, Chinese)

■ Remote Control

- Convenient remote control to modify operation status (Forward/Reverse operation, Frequency, etc)
- Easy parameter setting
- Available to control up to 31 Inverters
- RS-485, Modbus communication

User-friendly Interface & Easy Maintenance

The parameter setting becomes easier by adopting the 4 directions key. And iG5A supports easy maintenance via diagnosis and fan changeable structure.

■ Diagnosis of output module

Through easy parameter setting, iG5A can diagnose the status of output module.

■ Easy change of fan

iG5A is designed to be the fan changeable structure in preparation for a fan breakdown.



■ Cooling fan control

By controlling the cooling fan, iG5A provides a virtually quiet environment according to the status of operation.

■ User-friendly interface

The 4 directions key provides easy handling and monitoring.

■ External loader (Optional)

The external loader away from a panel enables to control and monitor conveniently. And the parameters made by external loader can be copied and applicable to other Inverters.



Model name	Remarks
INV, REMOTE KPD 2M (SV-iG5A)	2m
INV, REMOTE KPD 3M (SV-iG5A)	3m
INV, REMOTE KPD 5M (SV-iG5A)	5m



Compact Size

The compact size achieves cost-efficiency and various applications.

- Same height from 0.4 to 4.0kW (128mm)



Global standard compliance CE UL

- **Global standard**
iG5A series complies with CE and UL standards.
- **PNP/NPN input**
Both PNP and NPN inputs become possible and these enable to use the outer power.
To do so, users will be given wider choices of selecting the controller.

Model & Type

Applicable motor ranges	1 Phase 200V	3 Phase 200V	3 Phase 400V
0.4kW (0.5HP)	SV004iG5A-1	SV004iG5A-2	SV004iG5A-4
0.75kW (1HP)	SV008iG5A-1	SV008iG5A-2	SV008iG5A-4
1.5kW (2HP)	SV015iG5A-1	SV015iG5A-2	SV015iG5A-4
2.2kW (3HP)		SV022iG5A-2	SV022iG5A-4
3.7kW (5HP)		SV037iG5A-2	SV037iG5A-4
4.0kW (5.4HP)		SV040iG5A-2	SV040iG5A-4
5.5kW (7.5HP)		SV055iG5A-2	SV055iG5A-4
7.5kW (10HP)		SV075iG5A-2	SV075iG5A-4
11.0kW (15HP)		SV110iG5A-2	SV110iG5A-4
15.0kW (20HP)		SV150iG5A-2	SV150iG5A-4
18.5kW (25HP)		SV185iG5A-2	SV185iG5A-4
22.0kW (30HP)		SV220iG5A-2	SV220iG5A-4

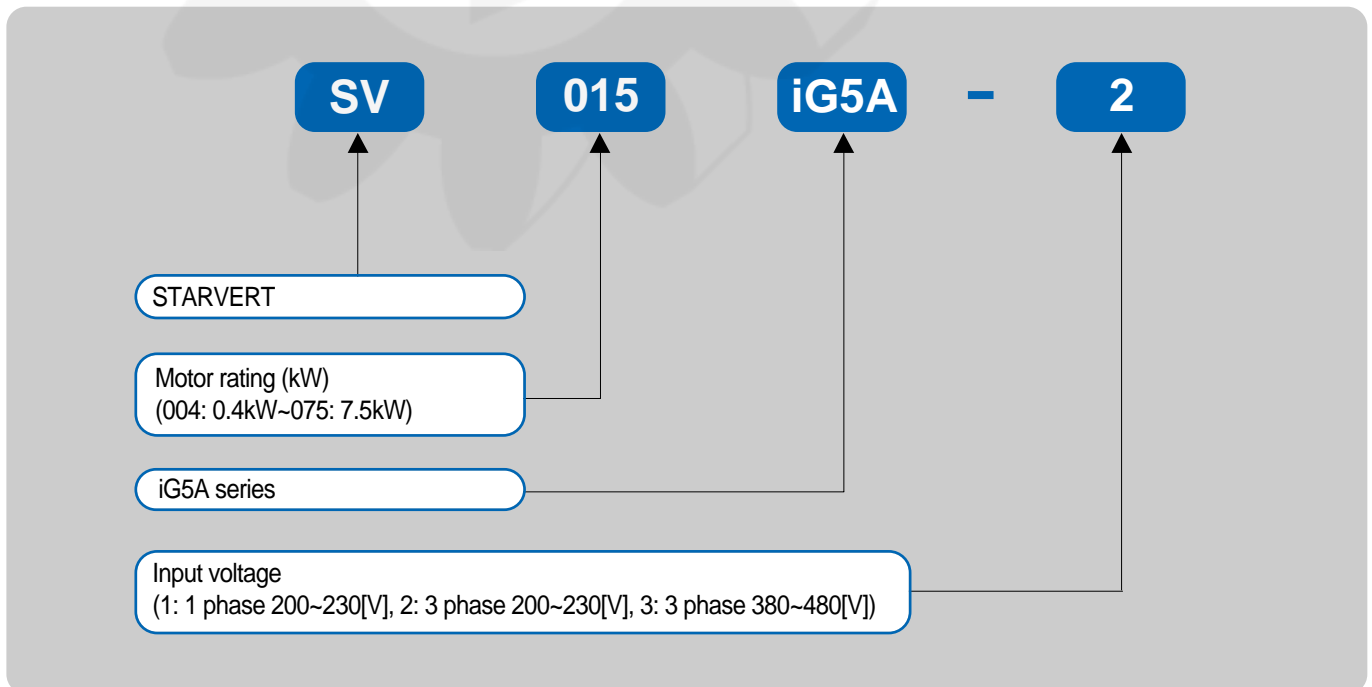

Standard Specifications

1 Phase 200V

SV 变频 iG5A-1 变频		004	008	015
Max. capacity ¹⁾	(HP)	0.5	1	2
	(kW)	0.4	0.75	1.5
Output rating	Capacity (kVA) ²⁾	0.95	1.9	3.0
	FLA (A) ³⁾	2.5	5	8
	Max frequency	400 [Hz] ⁴⁾		
	Max voltage	3 phase 200~230V ⁵⁾		
Input rating	Rated voltage	1phase 200~230 VAC (+10%, -15%)		
	Rated frequency	50~60 [Hz] (± 5%)		
Cooling method		Forced air cooling		
Weight (kg)		0.76	1.12	1.84

3 Phase 200V

SV 变频 iG5A-2 变频		004	008	015	022	037	040	055	075	110	150	185	220
Max. capacity ¹⁾	(HP)	0.5	1	2	3	5	5.4	7.5	10	15	20	25	30
	(kW)	0.4	0.75	1.5	2.2	3.7	4.0	5.5	7.5	11	15	18.5	22
Output rating	Capacity (kVA) ²⁾	0.95	1.9	3.0	4.5	6.1	6.5	9.1	12.2	17.5	22.9	28.2	33.5
	FLA (A) ³⁾	2.5	5	8	12	16	17	24	32	46	60	74	88
	Max frequency	400 [Hz] ⁴⁾											
	Max voltage	3 phase 200~230V ⁵⁾											
Input rating	Rated voltage	3 phase 200~230 (+10%, -15%)											
	Rated frequency	50~60 [Hz] (± 5%)											
Cooling method		N/C ⁶⁾	Forced air cooling										
Weight (kg)		0.76	0.77	1.12	1.84	1.89	1.89	3.66	3.66	9.0	9.0	13.3	13.3

3 Phase 400V

SV 变频 iG5A-4 变频		004	008	015	022	037	040	055	075	110	150	185	220
Max. capacity ¹⁾	(HP)	0.5	1	2	3	5	5.4	7.5	10	15	20	25	30
	(kW)	0.4	0.75	1.5	2.2	3.7	4.0	5.5	7.5	11	15	18.5	22
Output rating	Capacity (kVA) ²⁾	0.95	1.9	3.0	4.5	6.1	6.5	9.1	12.2	18.3	22.9	29.7	34.3
	FLA (A) ³⁾	1.25	2.5	4	6	8	9	12	16	24	30	39	45
	Max frequency	400 [Hz] ⁴⁾											
	Max voltage	3 phase 380~480V ⁵⁾											
Input rating	Rated voltage	3 phase 380~480 VAC (+10%, -15%)											
	Rated frequency	50~60 [Hz] (± 5%)											
Cooling method		N/C ⁶⁾	Forced air cooling										
Weight (kg)		0.76	0.77	1.12	1.84	1.89	1.89	3.66	3.66	9.0	9.0	13.3	13.3

1) Indicate the maximum applicable motor capacity when using 4 pole LS standard motor.

2) Rated capacity is based on 220V for 200V series and 440V for 400V series.

3) Refer to 15-3 of user's manual when carrier frequency setting (39) is above 3kHz.

4) Max. frequency setting range is extended to 300Hz when H40 (Control mode select) is set to 3 (Sensorless vector control).

5) Max. output voltage cannot be higher than the input voltage. It can be programmable below input voltage.

6) Self-Cooling

Standard Specifications

Control	Control method		V/F, Sensorless vector control	
	Frequency setting resolution		Digital command: 0.01Hz Analog command: 0.06Hz (Max. freq.: 60Hz)	
	Frequency accuracy		Digital command: 0.01% of Max. output frequency Analog command: 0.1% of Max. output frequency	
	V/F pattern		Linear, Squared, User V/F	
	Overload capacity		150% per 1 min.	
	Torque boost		Manual/Auto torque boost	
	Dynamic braking	Max. braking torque	20% ¹⁾	
Max. Duty		150% when using optional DB resistor ²⁾		
Operation	Operation mode		Keypad/ Terminal/ Communication option/ Remote keypad selectable	
	Frequency setting		Analog: 0~10V, -10~10V, 0~20mA Digital: Keypad	
	Operation features		PID, Up-down, 3-wire	
	Input	Multi-function terminal P1~P8	NPN/PNP selectable	
			FWD/REV RUN, Emergency stop, Fault reset, Jog operation, Multi-step Frequency-High, Mid, Low, Multi-step Accel/Decel-High, Mid, Low, DC braking at stop, 2nd motor select, Frequency UP/Down, 3-wire operation, External trip A, B, PID-Inverter (V/F) operation bypass, Option-inverter (V/F) operation bypass, Analog Hold, Accel/Decel stop	
	Output	Open collector terminal	Fault output and inverter status output	Less than DC 24V, 50mA
		Multi-function relay		(N.O., N.C.) Less than AC 250V, 1A; Less than DC 30V, 1A
	Analog output (AM)	0~10Vdc (less than 10mA): Output freq, Output current, Output voltage, DC link selectable		
Protective function	Trip		Over voltage, Under voltage, Over current, Ground fault current detection, Inverter overheat, Motor overheat, Output phase open, Overload protection, Communication error, Loss of speed command, Hardware fault, Fan trip	
	Alarm		Stall prevention, Overload	
	Momentary power loss		Below 15 msec.: Continuous operation (Should be within rated input voltage, rated output power.) Above 15 msec.: Auto restart enable	
Environment	Protection degree		IP 20, NEMA1 (Optional)	
	Ambient temp		-10 ~50	
	Storage temp		-20 ~65	
	Humidity		Below 90% RH (No condensation)	
	Altitude/Vibration		Below 1,000m, 5.9m/sec ² (0.6G)	
	Atmospheric pressure		70~106 kPa	
	Location		Protected from corrosive gas, Combustible gas, Oil mist or dust	

¹⁾ Means average braking torque during Decel to stop of a motor.

²⁾ Refer to Chapter 16 of user's manual for DB resistor specification.

Wiring

0.4~7.5kW

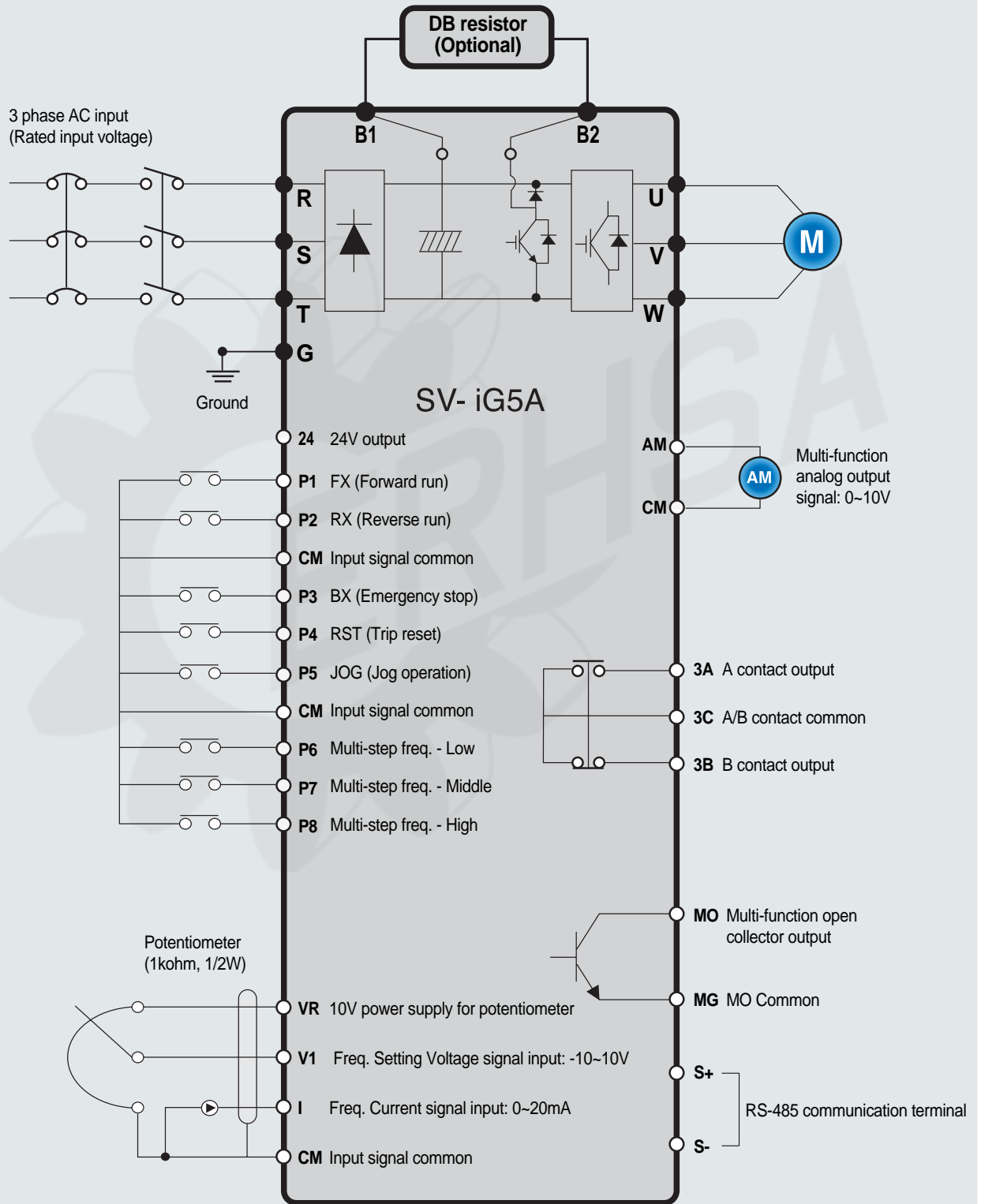

11.0~22.0kW

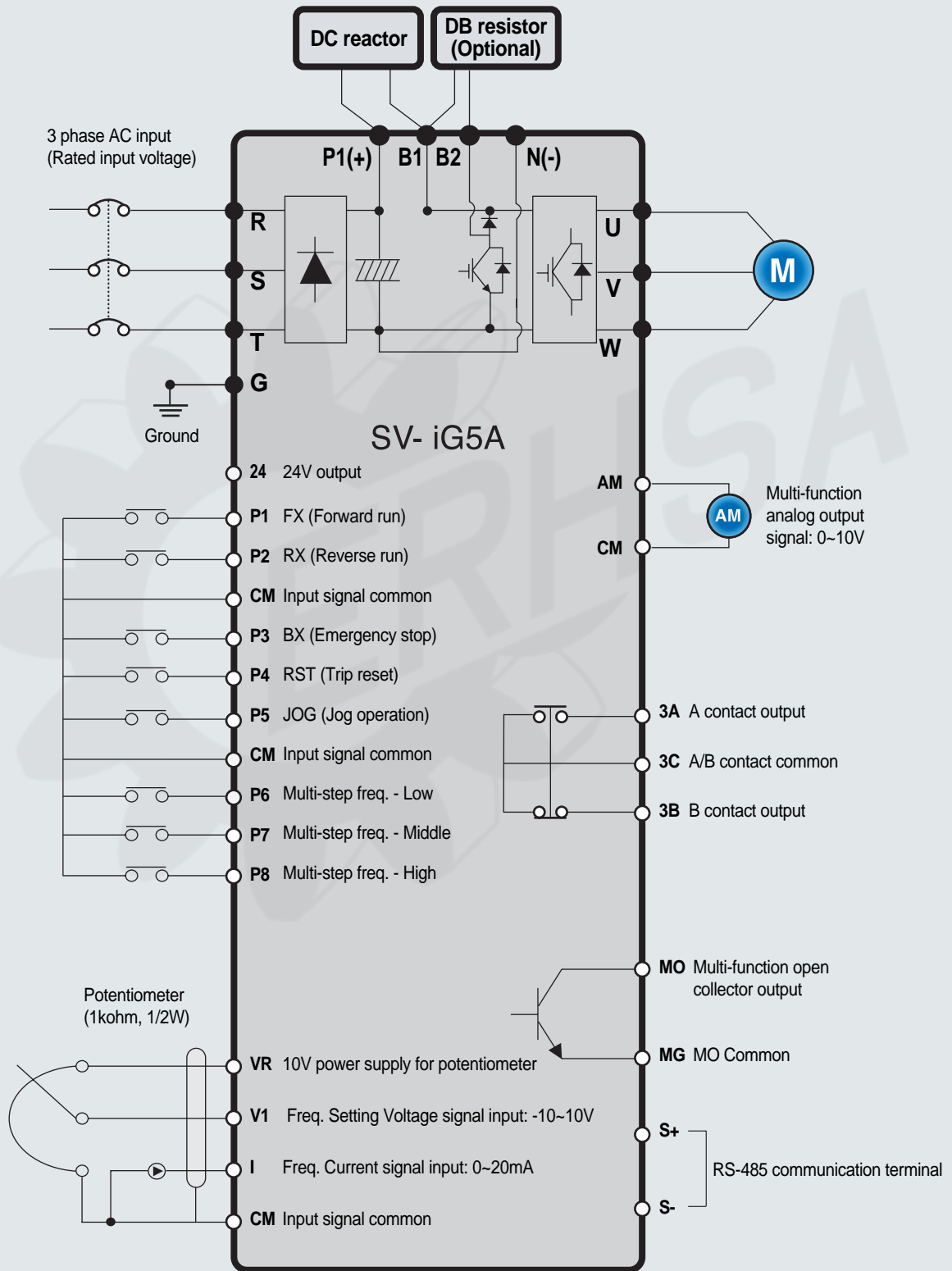

Terminal Configuration

Specifications for power terminal block wiring

- 0.4kW~0.75kW (1 phase)

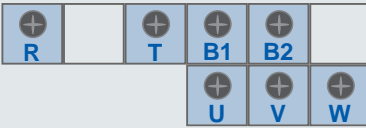

- 0.4kW~1.5kW (3 phase)

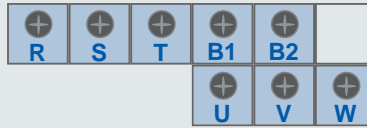

- 1.5kW (1 phase)



- 2.2~4.0kW (3 phase)



- 5.5kW~7.5kW (3 phase)

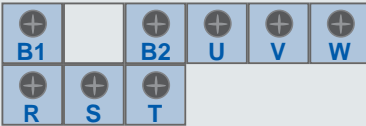

- 11~22kW (3 phase)



	R, S, T wire		U, V, W wire		Ground wire		Terminal Screw Size	Screw Torque (kgf.cm) / lb-in
	mm ²	AWG	mm ²	AWG	mm ²	AWG		
SV004iG5A-1	2	14	2	14	3.5	12	M3.5	10/8.7
SV008iG5A-1	2	14	2	14	3.5	12	M3.5	10/8.7
SV015iG5A-1	2	14	2	14	3.5	12	M4	15/13
SV004iG5A-2	2	14	2	14	3.5	12	M3.5	10/8.7
SV008iG5A-2	2	14	2	14	3.5	12	M3.5	10/8.7
SV015iG5A-2	2	14	2	14	3.5	12	M3.5	10/8.7
SV022iG5A-2	2	14	2	14	3.5	12	M4	15/13
SV037iG5A-2	3.5	12	3.5	12	3.5	12	M4	15/13
SV040iG5A-2	3.5	12	3.5	12	3.5	12	M4	15/13
SV055iG5A-2	5.5	10	5.5	10	5.5	10	M5	32/28
SV075iG5A-2	8	8	8	8	5.5	10	M5	32/28
SV110iG5A-2	14	6	14	6	14	6	M6	30.7/26.6
SV150iG5A-2	22	4	22	4	14	6	M6	30.7/26.6
SV185iG5A-2	30	2	30	2	22	4	M8	30.5/26.5
SV220iG5A-2	38	2	30	2	22	4	M8	30.5/26.5
SV004iG5A-4	2	14	2	14	2	14	M3.5	10/8.7
SV008iG5A-4	2	14	2	14	2	14	M3.5	10/8.7
SV015iG5A-4	2	14	2	14	2	14	M4	15/13
SV022iG5A-4	2	14	2	14	2	14	M4	15/13
SV037iG5A-4	2	14	2	14	2	14	M4	15/13
SV040iG5A-4	2	14	2	14	2	14	M4	15/13
SV055iG5A-4	3.5	12	2	14	3.5	12	M5	32/28
SV075iG5A-4	3.5	12	3.5	12	3.5	12	M5	32/28
SV110iG5A-4	5.5	10	5.5	10	8	8	M5	30.7/26.6
SV150iG5A-4	14	6	8	8	8	8	M5	30.7/26.6
SV185iG5A-4	14	6	8	8	14	6	M6	30.5/26.5
SV220iG5A-4	22	4	14	6	14	6	M6	30.5/26.5

Terminal Configuration

Control terminal specifications

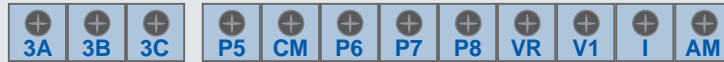

Terminal	Description	Wire size (mm ²)		Screw size	Torque (Nm) ¹⁾	Specification
		Single wire	Stranded			
P1~P8	Multi-function input T/M 1-8	1.0	1.5	M2.6	0.4	
CM	Common terminal	1.0	1.5	M2.6	0.4	
VR	Power supply for external potentiometer	1.0	1.5	M2.6	0.4	Output voltage: 12V Max. output current: 100mA Potentiometer: 1~5kohm
V1	Input terminal for voltage operation	1.0	1.5	M2.6	0.4	Max. input voltage: -12V~+12V input
I	Input terminal for current operation	1.0	1.5	M2.6	0.4	0~20mA input Internal resistor: 500ohm
AM	Multi-function analog output terminal	1.0	1.5	M2.6	0.4	Max. output voltage: 11V Max. output current: 100mA
MO	Multi-function terminal for open collector	1.0	1.5	M2.6	0.4	Below DC 26V, 100mA
MG	Ground terminal for external power supply	1.0	1.5	M2.6	0.4	
24	24V external power supply	1.0	1.5	M2.6	0.4	Max. output current: 100mA
3A	Multi-function relay output A contact	1.0	1.5	M2.6	0.4	Below AC 250V, 1A
3B	Multi-function relay output B contact	1.0	1.5	M2.6	0.4	Below DC 30V, 1A
3C	Common for multi-function relays	1.0	1.5	M2.6	0.4	

1) Use the recommended tightening torque when securing terminal screws.

When you use external power supply (24V) for multi-function input terminal (P1~P8), apply voltage higher than 12V to activate.

Tie the control wires more than 15cm away from the control terminals. Otherwise, it interferes front cover reinstallation.



Keypad Features



	Display	Term	Description
KEY	RUN	Run key	Run command
	STOP/RESET	STOP/RESET key	STOP: Stop command during operation, RESET: Reset command when a fault occurs.
		Up key	Used to scroll through codes or increase parameter value
		Down key	Used to scroll through codes or decrease parameter value
		Right key	Used to jump to other parameter groups or move a cursor to the right to change the parameter value
		Left key	Used to jump to other parameter groups or move a cursor to the left to change the parameter value
		Enter key	Used to set the parameter value or save the changed parameter value
LED ¹⁾	FWD	Forward run	Lit during forward run
	REV	Reverse run	Lit during reverse run
	RUN	Run key	Lit during operation
	SET	Setting	Lit during parameter setting

1) 4 LEDs above are set to blink when a fault occurs.

Dimensions

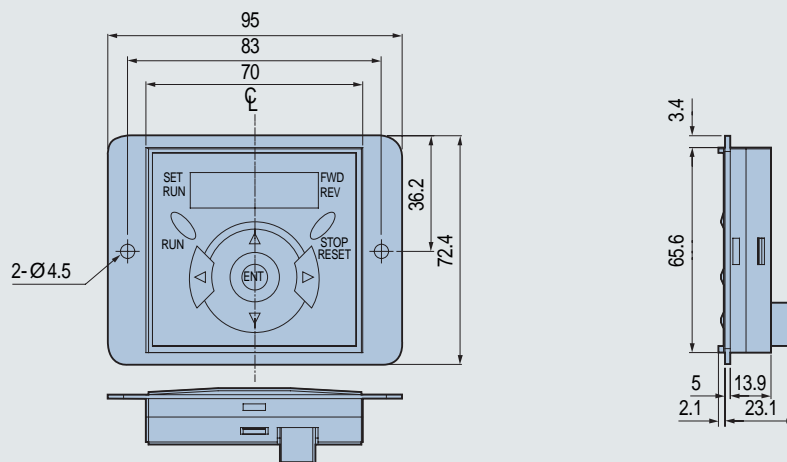

Moving to Other Groups

Parameter groups

There are 4 different parameter groups in iG5A series as shown below.

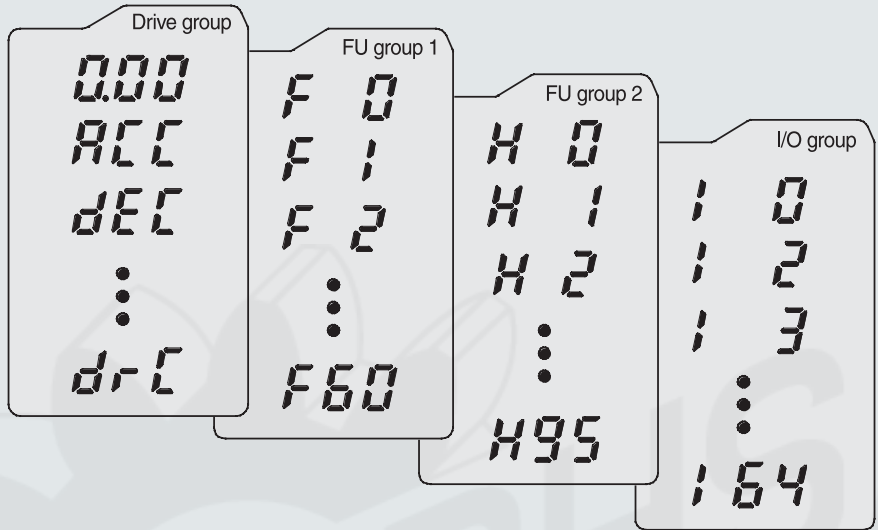

Parameter group	Description
Drive group	Basic parameters necessary for the inverter to run. Parameters such as Target frequency, Accel/Decel time settable.
Function group 1	Basic function parameters to adjust output frequency and voltage.
Function group 2	Advanced function parameters to set parameters for such as PID Operation and second motor operation.
I/O (Input/Output) group	Parameters necessary to make up a sequence using multi-function input/output terminal.

Moving to other groups

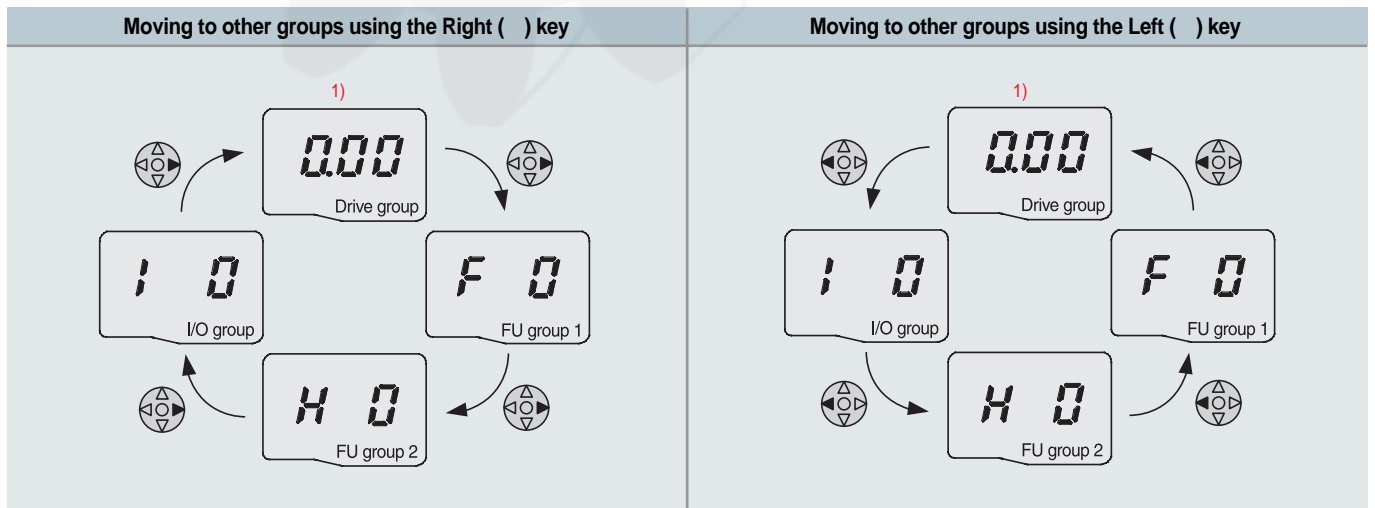

1) Target frequency can be set at 0.0 (the 1st code of drive group). Even though the preset value is 0.0, it is user-settable. The changed frequency will be displayed after it is changed.

Multi-step operation + Run/Stop via FX/RX + Max. frequency change

Operation condition

Operation command:
Run/Stop via FX/RX

Frequency command:
Multi-step operation [Low (20), Middle (30), High (80)]

Max. frequency change:
From 60Hz to 80Hz

Wiring

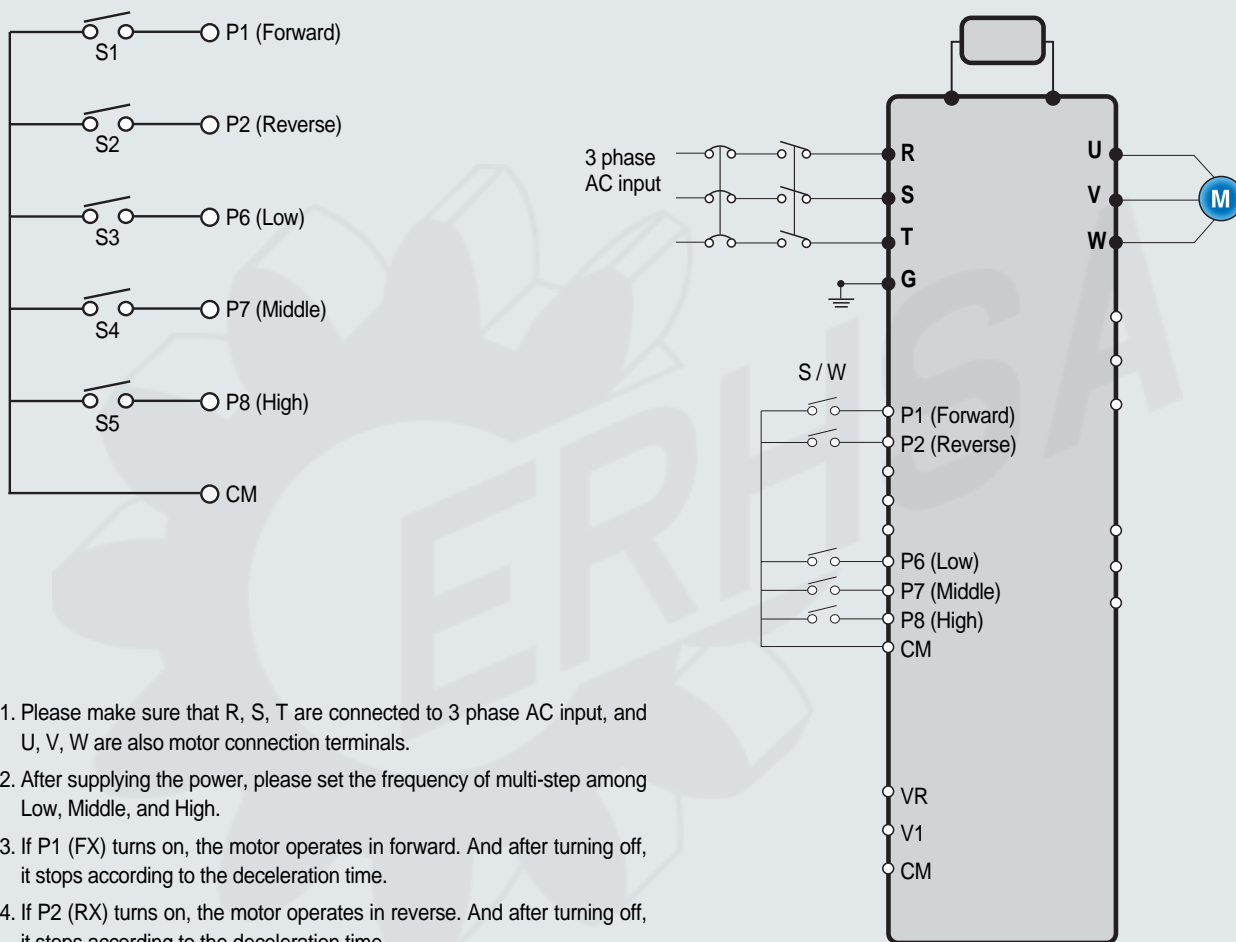

Parameter setting

Step	Command	Code	Description	Default	After change
1	Max. frequency change (FU1)	F21	Change Max. frequency.	60Hz	80Hz
2	Multi-step frequency (DRV)	st1	Set ' Low 'step.	10Hz	20Hz
3	Multi-step frequency (DRV)	st2	Set ' Middle 'step.	20Hz	30Hz
4	Multi-step frequency (I/O)	I30	Set ' High 'step.	30Hz	80Hz
5	Forward run (P1: FX)	I17	The default is FX. This value may change.	FX	FX
6	Reverse run (P2: RX)	I18	The default is RX. This value may change.	RX	RX

•• Potentiometer (Volume) + Run/Stop via FX/RX + Accel/Decel time change

Operation condition

Operation command: Run/Stop via FX/RX	Frequency command: 0~60Hz analog input via potentiometer	Accel/Decel time: Accel-10sec, Decel-20sec
--	---	---

Wiring

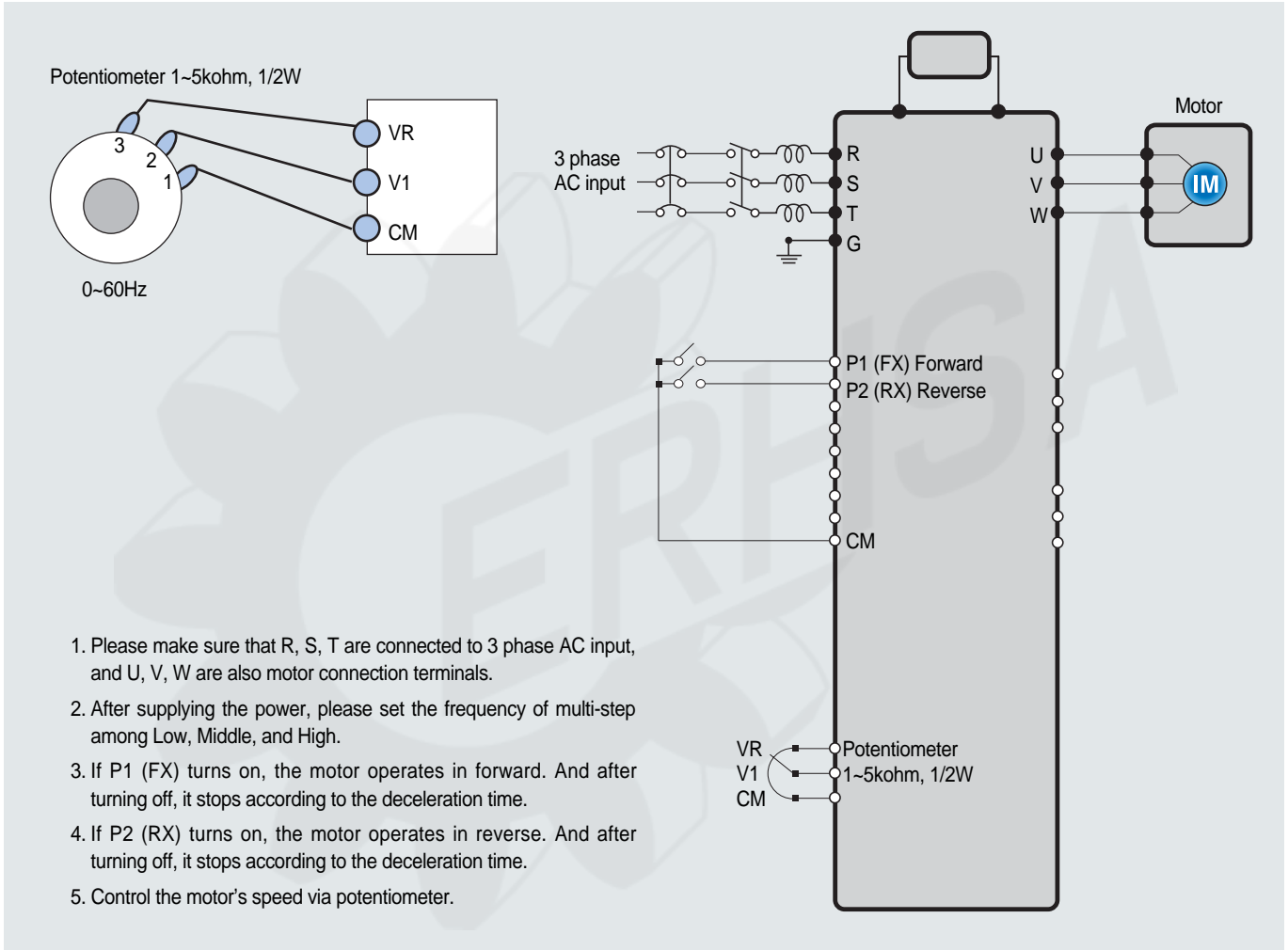

Parameter setting

Step	Command	Code	Description	Default	After change
1	Operation command (DRV group)	Drv	Turn on/off motor via terminal.	1 (FX/RX-1)	1 (FX/RX-1)
2	Analog input (DRV group)	Frq	Change keypad command to analog voltage command.	0 (Keypad-1)	3 (V1: 0~10V)
3	Accel/Decel time (DRV group)	ACC dEC	Set Accel time to 10sec in ACC Set Decel time to 20sec in dEC.	5sec (Accel) 10sec (Decel)	10sec (Accel) 20sec (Decel)
4	Forward run (P1: FX)	I17	The default is FX. This value may change	FX	FX
5	Reverse run (P2: RX)	I18	The default is RX. This value may change.	RX	RX

Dimensions

SV004iG5A-2 / SV008iG5A-2, SV004iG5A-4 / SV008iG5A-4

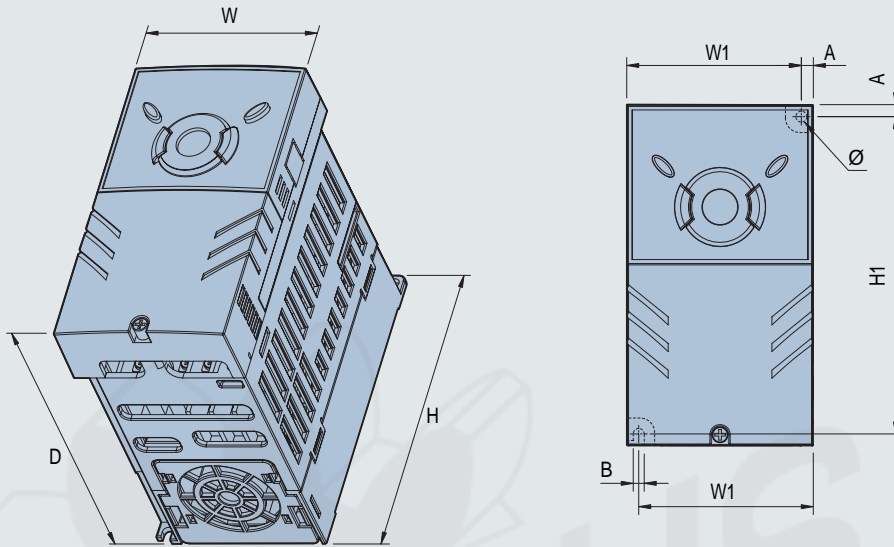

mm (inches)

Inverter model	(kW)	W (mm)	W1 (mm)	H (mm)	H1 (mm)	D (mm)	Ø	A (mm)	B (mm)	(kg)
SV004iG5A-2	0.4	70	65.5	128	119	130	4.0	4.5	4.0	0.76
SV008iG5A-2	0.75	70	65.5	128	119	130	4.0	4.5	4.0	0.77
SV004iG5A-4	0.4	70	65.5	128	119	130	4.0	4.5	4.0	0.76
SV008iG5A-4	0.75	70	65.5	128	119	130	4.0	4.5	4.0	0.77

SV015iG5A-2 / SV015iG5A-4

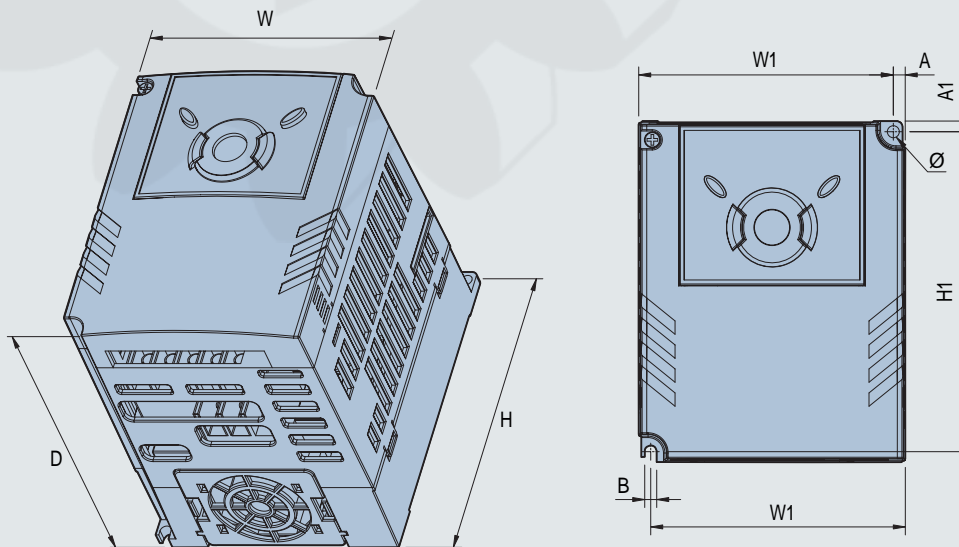

mm (inches)

Inverter model	(kW)	W (mm)	W1 (mm)	H (mm)	H1 (mm)	D (mm)	Ø	A (mm)	B (mm)	(kg)
SV015iG5A-2	1.5	100	95.5	128	120	130	4.5	4.5	4.5	1.12
SV015iG5A-4	1.5	100	95.5	128	120	130	4.5	4.5	4.5	1.12

SV022iG5A-2 / SV037iG5A-2 / SV040iG5A-2, SV022iG5A-4 / SV037iG5A-4 / SV040iG5A-4

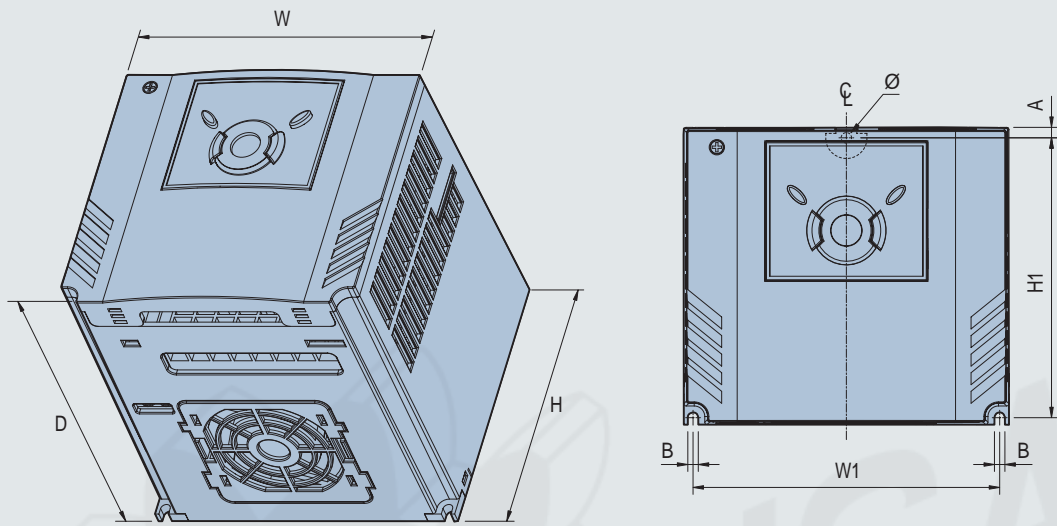

mm (inches)

Inverter model	(kW)	W (mm)	W1 (mm)	H (mm)	H1 (mm)	D (mm)	Ø	A (mm)	B (mm)	(kg)
SV022iG5A-2	2.2	140	132	128	120.5	155	4.5	4.5	4.5	1.84
SV037iG5A-2	3.7	140	132	128	120.5	155	4.5	4.5	4.5	1.89
SV040iG5A-2	4.0	140	132	128	120.5	155	4.5	4.5	4.5	1.89
SV022iG5A-4	2.2	140	132	128	120.5	155	4.5	4.5	4.5	1.84
SV037iG5A-4	3.7	140	132	128	120.5	155	4.5	4.5	4.5	1.89
SV040iG5A-4	4.0	140	132	128	120.5	155	4.5	4.5	4.5	1.89

SV055iG5A-2 / SV075iG5A-2, SV055iG5A-4 / SV075iG5A-4

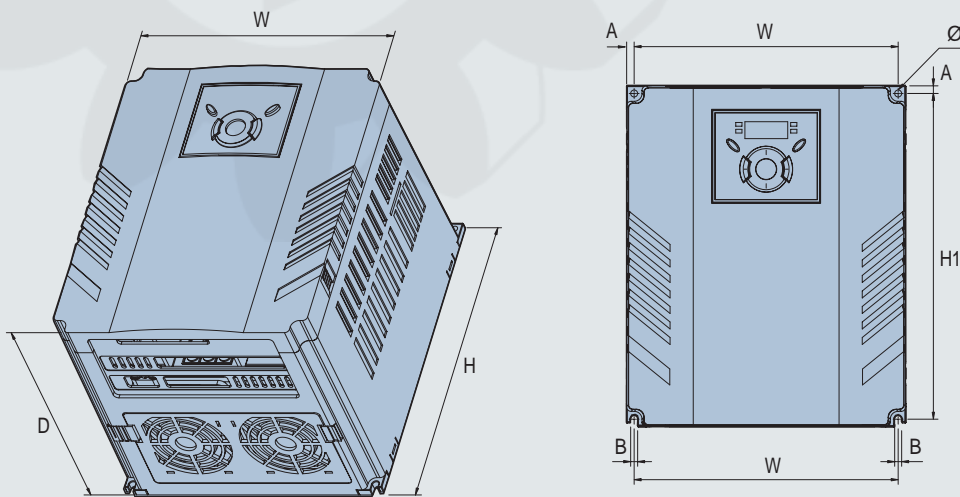

mm (inches)

Inverter model	(kW)	W (mm)	W1 (mm)	H (mm)	H1 (mm)	D (mm)	Ø	A (mm)	B (mm)	(kg)
SV055iG5A-2	5.5	180	170	220	210	170	4.5	5	4.5	3.66
SV075iG5A-2	7.5	180	170	220	210	170	4.5	5	4.5	3.66
SV055iG5A-4	5.5	180	170	220	210	170	4.5	5	4.5	3.66
SV075iG5A-4	7.5	180	170	220	210	170	4.5	5	4.5	3.66

Dimensions

SV110iG5A-2 / SV150iG5A-2 / SV110iG5A-4 / SV150iG5A-4

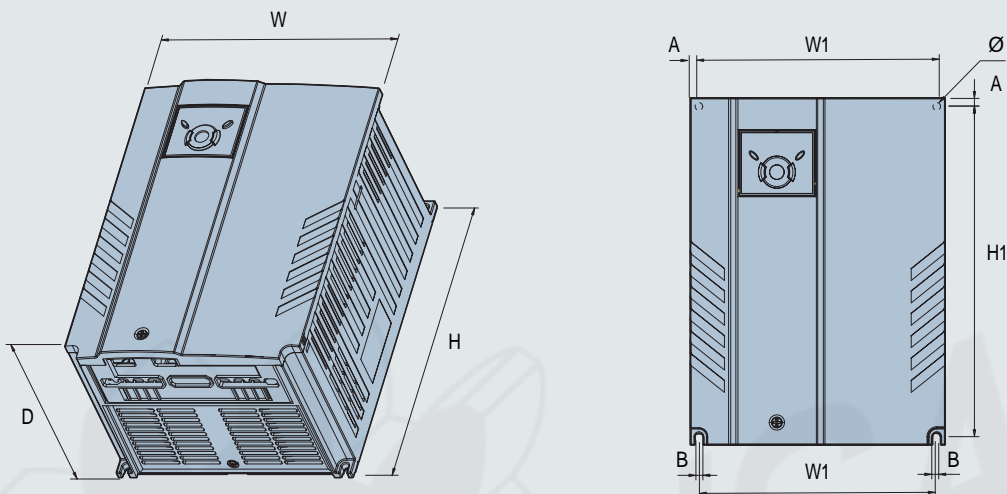

mm (inches)

Inverter model	(kW)	W (mm)	W1 (mm)	H (mm)	H1 (mm)	D (mm)	Ø	A (mm)	B (mm)	(kg)
SV110iG5A-2	11.0	235	219	320	304	189.5	7.0	8.0	7.0	9.00
SV150iG5A-2	15.0	235	219	320	304	189.5	7.0	8.0	7.0	9.00
SV110iG5A-4	11.0	235	219	320	304	189.5	7.0	8.0	7.0	9.00
SV150iG5A-4	15.0	235	219	320	304	189.5	7.0	8.0	7.0	9.00

SV185iG5A-2 / SV220iG5A-2 / SV185iG5A-4 / SV220iG5A-4

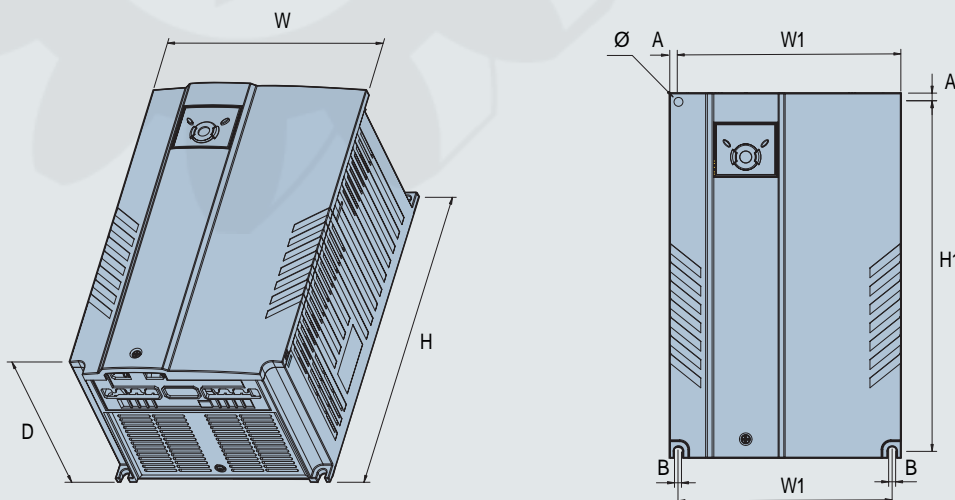

mm (inches)

Inverter model	(kW)	W (mm)	W1 (mm)	H (mm)	H1 (mm)	D (mm)	Ø	A (mm)	B (mm)	(kg)
SV185iG5A-2	18.5	260	240	410	392	208.5	10.0	10.0	10.0	13.3
SV220iG5A-2	22.0	260	240	410	392	208.5	10.0	10.0	10.0	13.3
SV185iG5A-4	18.5	260	240	410	392	208.5	10.0	10.0	10.0	10.0
SV220iG5A-4	22.0	260	240	410	392	208.5	10.0	10.0	10.0	10.0

Braking Resistors and Peripheral Devices

Braking resistors

Voltage	Inverter	100% braking		150% braking	
		Resistor [Ω]	Watt [W] ¹⁾	Resistor [Ω]	Watt [W] ¹⁾
200V Series	0.4	400	50	300	100
	0.75	200	100	150	150
	1.5	100	200	60	300
	2.2	60	300	50	400
	3.7	40	500	33	600
	5.5	30	700	20	800
	7.5	20	1,000	15	1,200
	11.0	15	1,400	10	2,400
	15.0	11	2,000	8	2,400
	18.5	9	2,400	5	3,600
400V Series	22.0	8	2,800	5	3,600
	0.4	1,800	50	1,200	100
	0.75	900	100	600	150
	1.5	450	200	300	300
	2.2	300	300	200	400
	3.7	200	500	130	600
	5.5	120	700	85	1,000
	7.5	90	1,000	60	1,200
	11.0	60	1,400	40	2,000
	15.0	45	2,000	30	2,400
18.5	35	2,400	20	3,600	
22.0	30	2,800	20	3,600	

1) The wattage is based on Enable Duty (%ED) with continuous braking time 15sec.

Breakers

Model	Breaker	
	Current [A]	Voltage [V]
004iG5A-1	ABS33b,EBs33	GMC-12
008iG5A-1	ABS33b,EBs33	GMC-12
015iG5A-1	ABS33b,EBs33	GMC-12
004iG5A-2	ABS33b,EBs33	GMC-12
004iG5A-2	ABS33b,EBs33	GMC-12
008iG5A-2	ABS33b,EBs33	GMC-12
015iG5A-2	ABS33b,EBs33	GMC-12
022iG5A-2	ABS33b,EBs33	GMC-18
037iG5A-2	ABS33b,EBs33	GMC-22
040iG5A-2	ABS33b,EBs33	GMC-22
055iG5A-2	ABS53b,EBs53	GMC-22
075iG5A-2	ABS103b,EBs53	GMC-32
110iG5A-2	ABS103b,EBs53	GMC-50
150iG5A-2	ABS203b,EBs53	GMC-65

Model	Breaker	
	Current [A]	Voltage [V]
185iG5A-2	ABS203b,EBs53	GMC-85
220iG5A-2	ABS203b,EBs53	GMC-100
004iG5A-4	ABS33b,EBs33	GMC-12
008iG5A-4	ABS33b,EBs33	GMC-12
015iG5A-4	ABS33b,EBs33	GMC-12
022iG5A-4	ABS33b,EBs33	GMC-22
037iG5A-4	ABS33b,EBs33	GMC-22
040iG5A-4	ABS33b,EBs33	GMC-22
055iG5A-4	ABS33b,EBs33	GMC-22
075iG5A-4	ABS33b,EBs33	GMC-22
110iG5A-4	ABS53b,EBs53	GMC-22
150iG5A-4	ABS103b,EBs53	GMC-25
185iG5A-4	ABS103b,EBs53	GMC-40
220iG5A-4	ABS103b,EBs53	GMC-50

Braking Resistors and Peripheral Devices

⚙️ Fuses & AC reactors

Model	AC external fuse		AC reactor	DC reactor
	Current [A]	Voltage [V]		
004iG5A-1	10 A	500V	4.20 mH, 3.5 A	-
008iG5A-1	10 A	500V	2.13 mH, 5.7 A	-
015iG5A-1	15 A	500V	1.20 mH, 10 A	-
004iG5A-2	10 A	500V	4.20 mH, 3.5 A	-
008iG5A-2	10 A	500V	2.13 mH, 5.7 A	-
015iG5A-2	15 A	500V	1.20 mH, 10 A	-
022iG5A-2	25 A	500V	0.88 mH, 14 A	-
037iG5A-2	30 A	500V	0.56 mH, 20 A	-
040iG5A-2	30 A	500V	0.56 mH, 20 A	-
055iG5A-2	30 A	500V	0.39 mH, 30 A	-
075iG5A-2	50 A	500V	0.28 mH, 40 A	-
110iG5A-2	70 A	500V	0.20 mH, 59 A	0.74 mH, 56 A
150iG5A-2	100 A	500V	0.15 mH, 75 A	0.57 mH, 71 A
185iG5A-2	100 A	500V	0.12 mH, 96 A	0.49 mH, 91 A
220iG5A-2	125 A	500V	0.10 mH, 112 A	0.42 mH, 107 A
004iG5A-4	5 A	500V	18.0 mH, 1.3 A	-
008iG5A-4	10 A	500V	8.63 mH, 2.8 A	-
015iG5A-4	10 A	500V	4.81 mH, 4.8 A	-
022iG5A-4	10 A	500V	3.23 mH, 7.5 A	-
037iG5A-4	20 A	500V	2.34 mH, 10 A	-
040iG5A-4	20 A	500V	2.34 mH, 10 A	-
055iG5A-4	20 A	500V	1.22 mH, 15 A	-
075iG5A-4	30 A	500V	1.14 mH, 20 A	-
110iG5A-4	35 A	500V	0.81 mH, 30 A	2.76 mH, 29 A
150iG5A-4	45 A	500V	0.61 mH, 38 A	2.18 mH, 36 A
185iG5A-4	60 A	500V	0.45 mH, 50 A	1.79 mH, 48 A
220iG5A-4	70 A	500V	0.39 mH, 58 A	1.54 mH, 55 A

Function List

Drive Group

LED display	Parameter name	Description	Factory default	Adj. during run
0.00	During stop: Frequency command During run: Output frequency	0~400Hz	0.00	Yes
ACC	Accel time	0~6000sec	5.0	Yes
dEC	Decel time		10.0	Yes
drv	Drive mode	0 (Keypad), 1 (FX/RX-1), 2 (FX/RX-2), 3 (RS-485)	1	No
Frq	Frequency setting method	0 (Keypad-1), 1 (Keypad-2), 2 (V1S: -10~10V), 3 (V1: 0~10V) 4 (I: 0~20mA), 5 (V1S+1), 6 (V1+I), 7 (RS-485), 8 (Digital volume)	0	No
St1	Multi-Step frequency 1	0~400Hz	10.00	Yes
St2	Multi-Step frequency 2		20.00	Yes
St3	Multi-Step frequency 3		30.00	Yes
CUr	Output current	A	-	-
rPM	Motor RPM	rpm	-	-
dCL	Inverter DC link voltage	V	-	-
vOL	User display select	vOL, Por, tOr	vOL	-
nOn	Fault display	-	nOn	-
drC	Direction of motor rotation select	F (Forward), R (Reverse)	F	Yes
Drv2	Drive mode 2	0 (Keypad), 1 (FX/RX-1), 2 (FX/RX-2)	1	No
Frq2	Frequency setting method 2	0 (Keypad-1), 1 (Keypad-2), 2 (V1S: 10~10V), 3 (V: 0~10V) 4 (I: 0~20mA), 5 (V1S+1), 6 (V1+I), 7 (RS-485)	0	No
rEF	Reference value for PID	0 ~ 400 [Hz] or 0 ~ 100 [%]	0.00	Yes
Fbk	Feedback value for PID	-	-	-

Function group 1

LED display	Parameter name	Description	Factory default	Adj. during run
F0	Jump code	0~71	1	Yes
F1	Forward/Reverse run disable	0 (Fwd and rev run enable), 1 (Forward run disable), 2 (Reverse run disable)	0	No
F2	Accel pattern	0 (Linear), 1 (S-curve)	0	No
F3	Decel pattern		0	
F4	Stop mode select	0 (Decelerate to stop), 1 (DC brake to stop), 2 (Free run to stop), 3 (Power braking)	0	No
F8 ¹⁾	DC brake start frequency	Start frequency, 0~60Hz	5.00	No
F9	DC brake wait time	0.1~60sec	0.1	No
F10	DC brake voltage	0~200%	50	No
F11	DC brake time	0~60sec	1.0	No
F12	DC brake start voltage	0~200%	50	No
F13	DC brake start time	0~60sec	0	No
F14	Time for magnetizing a motor	0~60sec	1.0	No
F20	Jog frequency	0~400Hz	10.00	Yes
F21 ²⁾	Max. frequency	40~400Hz	60.00	No
F22	Base frequency	30~400Hz	60.00	No
F23	Start frequency	0.1~10Hz	0.50	No
F24	Frequency high/low limit select	0 (NO), 1 (YES)	0 (No)	No
F25 ³⁾	Frequency high limit	Frequency low limit~frequency high limit	60.00	No
F26	Frequency low limit	0~frequency high limit	0.50	No

1) Only displayed when F4 is set to 1 (DC brake to stop).

2) If H40 is set to 3 (Sensorless vector), Max. frequency is settable up to 300Hz.

3) Only displayed when F24 (Frequency high/low limit select) is set to 1.

Function List

Function group 1

LED display	Parameter name	Description	Factory default	Adj. during run
F27	Torque Boost select	0 (Manual torque boost), 1 (Auto torque boost)	0	No
F28	Torque boost in forward direction	0~15%	5	No
F29	Torque boost in reverse direction		5	No
F30	V/F pattern	0 (Linear), 1 (Square), 2 (User V/F)	0	No
F31 ¹⁾	User V/F frequency 1	0~User V/F frequency2 [Hz]	15.00	No
F32	User V/F voltage 1	0~100%	25	No
F33	User V/F frequency 2	User V/F frequency1~User V/F frequency3 [Hz]	30.00	No
F34	User V/F voltage 2	0~100%	50	No
F35	User V/F frequency 3	User V/F frequency2~User V/F frequency4 [Hz]	45.00	No
F36	User V/F voltage 3	0~100%	75	No
F37	User V/F frequency 4	User V/F frequency3~Max. frequency [Hz]	60.00	No
F38	User V/F voltage 4	0~100%	100	No
F39	Output voltage adjustment	40~110%	100	No
F40	Energy-saving level	0~30%	0	Yes
F50	Electronic thermal select	0 (NO), 1 (YES)	0	Yes
F51 ²⁾	Electronic thermal level for 1 minute	50~200%	150	Yes
F52	Electronic thermal level for continuous	50~200%	100	Yes
F53	Motor cooling method	0 (Self-cooling), 1 (Post-cooling)	0	Yes
F54	Overload warning level	30~150%	150	Yes
F55	Overload warning time	0~30sec	10	Yes
F56	Overload trip select	0 (NO), 1 (YES)	1	Yes
F57	Overload trip level	30~200%	180	Yes
F58	Overload trip time	0~60sec	60	Yes
F59	Stall prevention select	0: Stall prevention disabled 1: During Accel 2: During constant run 3: During Accel, During constant run 4: During Decel 5: During Accel, During Decel 6: During Decel, During constant run 7: During Accel, During constant run, During Decel	0	No
F60	Stall prevention level	30~200%	150	No
F61	When Stall prevention during deceleration, voltage limit select	0 ~ 1	0	No
F63	Save up/down frequency select	0 ~ 1	0	No
F64	Save up/down frequency		0.00	No
F65	Up down mode select	0: Increases goal frequency as a standard of Max. frequency/Min.frequency 1: Increases as many as step frequency according to edge input 2: Available to combine 1 and 2	0	No
F66	Up-down step frequency	0 ~ 400 [Hz]	0.00	No
F70	Draw run mode select	0: Inverter doesn't run as a draw mode 1: V1(0~10V) input draw run 2: I(0~20mA) input draw run 3: V1(-10~10V) input draw run	0	No
F71	Draw rate	0 ~ 100 [%]	0.0	Yes

1) Set F30 to 2 (User V/F) to display this parameter.

2) Set F50 to 1 to display this parameter.

 **Function group 2**

LED display	Parameter name	Description	Factory default	Adj. during run
H0	Jump code	0~95	1	Yes
H1	Fault history 1		nOn	–
H2	Fault history 2		nOn	–
H3	Fault history 3		nOn	–
H4	Fault history 4		nOn	–
H5	Fault history 5		nOn	–
H6	Reset fault history	0 (No), 1 (Yes)	0 (NO)	Yes
H7	Dwell frequency	0~400Hz	5.00	No
H8	Dwell time	0~10sec	0.0	No
H10	Skip frequency select	0 (No), 1 (Yes)	0 (NO)	No
H11 ¹⁾	Skip frequency low limit 1	0~frequency high limit 1 [Hz]	10Hz	No
H12	Skip frequency high limit 1	Frequency high limit 1 [Hz]~Max. frequency [Hz]	15Hz	No
H13	Skip frequency low limit 2	0~frequency high limit 2 [Hz]	20Hz	No
H14	Skip frequency high limit 2	Frequency low limit 2 [Hz]~Max. frequency [Hz]	25Hz	No
H15	Skip frequency low limit 3	0~frequency high limit 3 [Hz]	30Hz	No
H16	Skip frequency high limit 3	Frequency low limit 3 [Hz]~Max. frequency [Hz]	35Hz	No
H17	S-Curve accel/decel start side	1~100%	40%	No
H18	S-Curve accel/decel end side	1~100%	40%	No
H19	Input/output phase loss protection select	0 (Disabled), 1 (Output phase protection), 2 (Input phase protection), 3 (Input/output phase protection)	0	Yes
H20	Power On Start select	0 (NO), 1 (YES)	0 (NO)	Yes
H21	Restart after fault reset selection	0 (NO), 1 (YES)	0 (NO)	
H22 ²⁾	Speed search select	0: Speed search disabled 1: Normal accel 2: Operation after fault 3: Normal accel, Operation after fault 4: Restart after instant power failure 5: Normal accel, Restart after instant power failure 6: Operation after fault, Restart after instant power failure 7: Normal accel, Operation after fault, Restart after instant power failure 8: Power On start 9: Normal accel, Power On start 10: Operation after fault, Power On start 11: Normal accel, Operation after fault, Power On start 12: Restart after instant power failure, Power On start 13: Normal accel, Restart after instant power failure, Power On start 14: Operation after fault, Restart after instant power failure, Power On start 15: Normal accel, Operation after fault, Restart after instant power failure, Power On start	0	Yes
H23	Current level during speed search	80~200%	100	Yes
H24	P gain during speed search	0~9999	100	Yes
H25	I gain during speed search	0~9999	1000	Yes
H26	Number of auto restart try	0~10	0	Yes
H27	Auto restart time	0~60sec	1sec	Yes
H30	Motor type select	0.2~22 [KW]	7.5 ³⁾	No
H31	Number of motor poles	2~12	4	No

1) Only displayed when H10 is set to 1. # H17, H18 are used when F2, F3 are set to 1 (S-curve).

2) Normal acceleration has first priority. Even though #4 is selected along with other bits, Inverter performs Speed search #4.

3) H30 is preset based on Inverter rating.

Function List

Function group 2

LED display	Parameter name	Description	Factory default	Adj. during run
H32	Rated slip frequency	0~10Hz	– 1)	No
H33	Motor rated current	1.0~150 [A]	–	No
H34	No load motor current	0.1~50 [A]	–	No
H36	Motor efficiency	50~100%	–	No
H37	Load inertia rate	0~2	0	No
H39	Carrier frequency select	1~15kHz	3kHz	Yes
H40	Control mode select	0 (Volts/frequency control), 1 (Slip compensation control), 2 (PID feedback control), 3 (Sensorless vector control)	0	No
H41	Auto tuning	0 (NO), 1 (YES)	–	No
H42	Stator resistance (Rs)	0~28 [Ω]	–	No
H44	Leakage inductance (Ls)	0~300.0mH	1000	Yes
H45 2)	Sensorless P gain	0~32767	100	Yes
H46	Sensorless I gain		0	No
H47	Sensorless torque limit	100~220 [%]	180.0	No
H48	PWM mode select	0: Normal PWM mode 1: 2 phase PWM mode	0	No
H49	PID control select	0~1	0	No
H50 3)	PID Feedback select	0 (1: 0~20mA), 1 (V1 0~10V)		
H51	P gain for PID controller	0~999.9%	300%	Yes
H52	Integral time for PID controller (I gain)	0.1~32.0sec	1sec	Yes
H53	Differential time for PID controller (D gain)	0.1~30.0sec	0sec	Yes
H54	F gain for PID controller	0~999.9%	0%	Yes
H55	PID output frequency limit	0.1~400Hz Max. frequency	60Hz	Yes
H56	PID output frequency low limit	0.1~400 [Hz]	0.50	Yes
H57	PID standard value select	0: Loader digital setting 1 1: Loader digital setting 2 2: V1 terminal setting 2: 0~10V 3: I terminal setting: 0~20mA 4: Setting as a RS-485 communication	0	No
H58	PID control unit select	0: Frequency [Hz] 1: Percentage [%]	0	No
H60	Diagnosis select	0: Diagnosis disabled 1: IGBT fault/ Ground-fault 2: Output phase short & Output open/ Ground-fault 3: Ground-fault	0	No
H61	Sleep delay time	0~2000 [sec]	60.0	No
H62	Sleep frequency	0~400 [Hz]	0.00	Yes
H63	Wake up level	0~100 [%]	35.0	Yes
H64	KEB drive select	0~1	0	No
H65	KEB action start level	110~140 [%]	125.0	No
H66	KEB action stop level	110~145 [%]	130.0	No
H67	KEB action gain	1~20,000	1000	No
H70	Frequency reference for accel/decel	0 (Based on Max. frequency), 1 (Based on delta frequency)	0	No
H71	Accel/Decel time scale	0 (0.01 sec), 1 (0.1 sec), 2 (1 sec)	1 (0.1 sec)	Yes
H72	Power on display	0: Frequency command 1: Accel time 2: Decel time 3: Drive mode 4: Frequency mode 5: Multi-Step frequency 1 6: Multi-Step frequency 2 7: Multi-Step frequency 3 8: Output current 9: Motor rpm 10: Inverter DC link voltage 11: User display select (H73) 12: Fault display 13: Direction of motor rotation select 14: Output current 2 15: Motor rpm 2 16: Inverter DC link voltage 2 17: User display select 2	0	Yes
H73	Monitoring item select	0: Output voltage [V] 1: Output power [kW] 2: Torque [kgf · m]	0	Yes
H74	Gain for motor rpm display	1~1000%	100%	Yes
H75	DB resistor operating rate limit select	0: Unlimited 1: Use DB resistor for the H76 set time.	1	Yes
H76	DB resistor operating rate	0~30%	10%	Yes

1) H32-H36 factory default values are set based on LS motor.

2) Set H40 to 3 (Sensorless vector control) to display this parameter.

3) Set H40 to 2 (PID control) to display this parameter.

Function group 2

LED display	Parameter name	Description	Factory default	Adj. during run	
H77 ¹⁾	Cooling fan control	0 (Always ON), 1 (Keep ON when its Temp. is higher than Inverter protection limit Temp.)	0	Yes	
H78	Operating method select when cooling fan malfunctions	0 (Run when cooling fan malfunctions), 1 (Stop when cooling fan malfunctions)	0	Yes	
H79	S/W version	0~10.0	1.0	No	
H81	2nd motor Accel time	0~6000sec	5.0	Yes	
H82	2nd motor Decel time		10.0	Yes	
H83	2nd motor base frequency	30~400Hz	60.00	No	
H84	2nd motor V/F pattern	0 (Linear), 1 (Square), 2 (User V/F)	0	No	
H85	2nd motor forward torque boost	0~15%	5	No	
H86	2nd motor reverse torque boost		5	No	
H87	2nd motor stall prevention level	30~150%	150%	No	
H88	2nd motor Electronic thermal level for 1 min	50~200%	150%	Yes	
H89	2nd motor Electronic thermal level for continuous	50~150%	100%	Yes	
H90	2nd motor rated current	0.1~100 [A]	26.3	No	
H91	Parameter read	0~1	0	No	
H92	Parameter write	0~1	0	No	
H93	Parameter initialize	0~5	0	No	
H94	Password register	0~FFFF	0	Yes	
H95	Parameter lock	UL (Unlock)	Parameter change enable	0	Yes
		L (Lock)	Parameter change disable		

1) Exception SV004iG5A-2/SV004iG5A-4 adopt self-cooling type, so this code is hidden.

Input/output group

LED display	Parameter name	Description	Factory default	Adj. during run
I0	Jump code	0~87	1	Yes
I1	Filter time constant for NV input	0~9999	10	Yes
I2	NV input Min. voltage	0~10V	0.00	Yes
I3	Frequency corresponding to I2	0~Max. frequency [Hz]	0.00	Yes
I4	NV input Max. voltage	0~10V	10.0	Yes
I5	Frequency corresponding to I4	0~Max. frequency [Hz]	60.00	Yes
I6	Filter time constant for V1 input	0~9999	10	Yes
I7	V1 input Min. voltage	0~10V	0	Yes
I8	Frequency corresponding to I7	0~Max. frequency [Hz]	0.00	Yes
I9	V1 input Max. voltage	0~10V	10	Yes
I10	Frequency corresponding to I9	0~Max. frequency [Hz]	60.00	Yes
I11	Filter time constant for I input	0~9999	10	Yes
I12	I input Min. current	0~20mA	4.00	Yes
I13	Frequency corresponding to I12	0~Max. frequency [Hz]	0.00	Yes
I14	I input Max. current	0~20mA	20.00	Yes
I15	Frequency corresponding to I14	0~Max. frequency [Hz]	60.00	Yes

Function List

















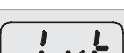

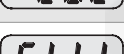
Input/output group

LED display	Parameter name	Description	Factory default	Adj. during run																
I16	Criteria for analog input signal loss	0: Disabled 1: activated below half of set value. 2: activated below set value.	0	Yes																
I17	Multi-function input terminal P1 define	0: Forward run command 1: Reverse run command 2: Emergency stop trip 3: Reset when a fault occurs (RST)	0	Yes																
I18	Multi-function input terminal P2 define	4: Jog operation command 5: Multi-step freq - Low 6: Multi-step freq - Mid 7: Multi-step freq - High	1	Yes																
I19	Multi-function input terminal P3 define	8: Multi Accel/Decel - Low 9: Multi Accel/Decel - Mid 10: Multi Accel/Decel - High	2	Yes																
I20	Multi-function input terminal P4 define	11: DC brake during stop 12: 2nd motor select 13: -Reserved-	3	Yes																
I21	Multi-function input terminal P5 define	14: -Reserved- 15: Up-down Frequency increase (UP)command 16: Up-down Frequency decrease command (DOWN)	4	Yes																
I22	Multi-function input terminal P6 define	17: 3-wire operation 18: External trip A contact (EtA) 19: External trip B contact (EtB) 20: -	5	Yes																
I23	Multi-function input terminal P7 define	21: Exchange between PID operation and V/F operation 22: Exchange between option and Inverter 23: Analog hold 24: Accel/Decel disable	6	Yes																
I24	Multi-function input terminal P8 define	25: Up/Down save freq. Initialization 26: JOG-FX 8-3 27: JOG-RX	7	Yes																
I25	Input terminal status display	<table border="1"> <tr> <td>BIT7</td><td>BIT6</td><td>BIT5</td><td>BIT4</td><td>BIT3</td><td>BIT2</td><td>BIT1</td><td>BIT0</td> </tr> <tr> <td>P8</td><td>P7</td><td>P6</td><td>P5</td><td>P4</td><td>P3</td><td>P2</td><td>P1</td> </tr> </table>	BIT7	BIT6	BIT5	BIT4	BIT3	BIT2	BIT1	BIT0	P8	P7	P6	P5	P4	P3	P2	P1	-	-
BIT7	BIT6	BIT5	BIT4	BIT3	BIT2	BIT1	BIT0													
P8	P7	P6	P5	P4	P3	P2	P1													
I26	Output terminal status display	<table border="1"> <tr> <td>BIT1</td><td>BIT0</td> </tr> <tr> <td>3AC</td><td>MO</td> </tr> </table>	BIT1	BIT0	3AC	MO	-	-												
BIT1	BIT0																			
3AC	MO																			
I27	Filtering time constant for multi-function input terminal	2-50	15	Yes																
I30	Multi-step frequency 4	0-Max. frequency [Hz]	30.00	Yes																
I31	Multi-step frequency 5		25.00	Yes																
I32	Multi-step frequency 6		20.00	Yes																
I33	Multi-step frequency 7		15.00	Yes																
I34	Multi-Accel time 1	0-6000sec	3.0	Yes																
I35	Multi-Decel time 1		3.0	Yes																
I36	Multi-Accel time 2		4.0	Yes																
I37	Multi-Decel time 2		4.0	Yes																
I38	Multi-Accel time 3		5.0	Yes																
I39	Multi-Decel time 3		5.0	Yes																
I40	Multi-Accel time 4		6.0	Yes																
I41	Multi-Decel time 4		6.0	Yes																
I42	Multi-Accel time 5		7.0	Yes																
I43	Multi-Decel time 5		7.0	Yes																
I44	Multi-Accel time 6		8.0	Yes																
I45	Multi-Decel time 6		8.0	Yes																
I46	Multi-Accel time 7		9.0	Yes																
I47	Multi-Decel time 7		9.0	Yes																
I50	Analog output item select	0 (Output freq.), 1 (Output current) 2 (Output voltage), 3 (Inverter DC link voltage)	-	Yes																

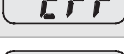

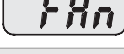









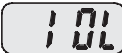

Input/output group

LED display	Parameter name	Description	Factory default	Adj. during run
I51	Analog output level adjustment	10~200%	100	Yes
I52	Frequency detection level	0~400Hz	30.00	Yes
I53	Frequency detection bandwidth		10.00	Yes
I54	Multi-function output terminal select	0: FDT-1 1: FDT-2 2: FDT-3 3: FDT-4 4: FDT-5	12	Yes
I55	Fault relay select	5: Overload (OL) 6: Inverter overload (IOL) 7: Motor stall (STALL) 8: Over voltage trip (OV) 9: Low voltage trip (LV) 10: Inverter overheat (OH) 11: Command loss 12: During run 13: During stop 14: During constant run 15: During speed searching 16: Wait time for run signal input 17: Fault relay select 18: Warning for cooling fan trip 19: Brake signal select	17	Yes
I56	Fault relay output	0: - 1: When the low voltage trip occurs 2: When the trip other than low voltage trip occurs 3: When the low voltage trip occurs, When the trip other than low voltage trip occurs 4: When setting the H26 (Number of auto restart try) 5: When the low voltage trip occurs, When setting the H26 (Number of auto restart try) 6: When the trip other than low voltage trip occurs, When setting the H26 (Number of auto restart try) 7: When the low voltage trip occurs, When the trip other than low voltage trip occurs, When setting the H26 (Number of auto restart try)	2	Yes
I57	Output terminal select when communication error occurs	0: - 1: Multi-function output terminal 2: Multi-function relay 3: Multi-function output terminal, Multi-function relay	0	Yes
I59	Communication protocol select	0 (Modbus RTU), 1 (LS BUS)	0	No
I60	Inverter number	1~Max. frequency [Hz]	1	Yes
I61	Baud rate	0: 1200bps 1: 2400bps 2: 4800bps 3: 9600bps 4: 19200bps	3	Yes
I62	Drive mode select after loss of frequency command	0: Continuous operation at the frequency before its command is lost. 1: Free run stop (Coast to stop) 2: Decel to stop	0	Yes
I63	Wait time after loss of frequency command	0.1~120 sec	1.0	Yes
I64	Communication time setting	2~100msec	5	Yes

Protective Functions

Keypad display	Protective functions	Descriptions
	Overcurrent	The inverter turns off its output when the output current of the inverter flows more than 200% of the inverter rated current.
	Ground fault current	The inverter turns off its output when a ground fault occurs and the ground fault current is more than the internal setting value of the inverter.
	Inverter Overload	The inverter turns off its output when the output current of the inverter flows more than the rated level (150% for 1 minute).
	Overload trip	The inverter turns off its output if the output current of the inverter flows at 150% of the inverter rated current for more than the current limit time (1min).
	Heat sink overheat	The inverter turns off its output if the heat sink overheats due to a damaged cooling fan or an alien substance in the cooling fan by detecting the temperature of the heat sink.
	Output Phase loss	The inverter turns off its output when the one or more of the output (U, V, W) phase is open. The inverter detects the output current to check the phase loss of the output.
	Over voltage	The inverter turns off its output if the DC voltage of the main circuit increases higher than 400V when the motor decelerates. This fault can also occur due to a surge voltage generated at the power supply system.
	Low voltage	The inverter turns off its output if the DC voltage is below 180V because insufficient torque or overheating of the motor can occur when the input voltage of the inverter drops.
	Electronic Thermal	The internal electronic thermal of the inverter determines the overheating of the motor. If the motor is overloaded, the inverter turns off the output. The inverter cannot protect the motor when driving a motor having more than 4 poles or multi motors.
	Input phase loss	Inverter output is blocked when one of R, S, T is open or the electrolytic capacitor needs to be replaced.
	Self-diagnostic malfunction	Displayed when IGBT damage, output phase short, output phase ground fault or output phase open occurs.
	Parameter save error	Displayed when user-setting parameters fails to be entered into memory.
	Inverter hardware fault	Displayed when an error occurs in the control circuitry of the inverter.
	Communication Error	Displayed when the inverter cannot communicate with the keypad.
	Remote keypad communication error	Displayed when the inverter and the remote keypad do not communicate with each other. It does not stop inverter operation.
	Keypad error	Displayed after the inverter resets the keypad when a keypad error occurs and this
	Cooling fan fault	Displayed when a fault condition occurs in the inverter cooling fan.
	Instant cut off	Used for the emergency stop of the inverter. The inverter instantly turns off the output when the EST terminal is turned on. Caution: The inverter starts to regular operation when turning off the EST terminal while FX or RX terminal is ON.
	External fault A contact input	When multi-function input terminal (I20-I24) is set to 19 {External fault signal input A: (Normal Open Contact)}, the inverter turns off the output.
	External fault B contact input	When multi-function input terminal (I20-I24) is set to 19 {External fault signal input B: (Normal Close Contact)}, the inverter turns off the output.
	Operating method when the frequency command is lost	When inverter operation is set via analog input (0-10V or 0-20mA input) or option (RS-485) and no signal is applied, operation is done according to the method set in I62 (Operating method when the frequency reference is lost).

Fault Remedy

Keypad display	Cause	Remedy
	Caution: When an overcurrent fault occurs, operation must be started after the cause is removed to avoid damage to IGBT inside the inverter.	
 Overcurrent	<p>Accel/Decel time is too short compared to the GD^2 of the load.</p> <p>Load is greater than the inverter rating.</p> <p>Inverter output is issued when the motor is free running.</p> <p>Output short circuit or ground fault has occurred.</p> <p>Mechanical brake of the motor is operating too fast.</p>	<p>Increase the Accel/Decel time.</p> <p>Replace the inverter with appropriate capacity.</p> <p>Resume operation after stopping the motor or use H22 (Speed search).</p> <p>Check output wiring.</p> <p>Check the mechanical brake.</p>
 Ground fault current	<p>Ground fault has occurred at the output wiring of the inverter.</p> <p>The insulation of the motor is damaged due to heat.</p>	<p>Check the wiring of the output terminal.</p> <p>Replace the motor.</p>
 Inverter overload	<p>Load is greater than the inverter rating.</p>	<p>Upgrade the capacity of motor and inverter or reduce the load weight.</p> <p>Reduce torque boost scale.</p>
 Overload trip	<p>Torque boost scale is set too large.</p>	
 Heat sink overheat	<p>Cooling system has faults.</p> <p>An old cooling fan is not replaced with a new one.</p> <p>Ambient temperature is too high.</p>	<p>Check for alien substances clogged in the heat sink.</p> <p>Replace the old cooling fan with a new one.</p> <p>Keep ambient temperature under 50 °C.</p>
 Output Phase loss	<p>Faulty contact of magnetic switch at output.</p> <p>Faulty output wiring.</p>	<p>Make connection of magnetic switch at output of the inverter securely.</p> <p>Check output wiring.</p>
 Cooling fan fault	<p>An alien substance is clogged in a ventilating slot.</p> <p>Inverter has been in use without changing a cooling fan.</p>	<p>Check the ventilating slot and remove the clogged substances.</p> <p>Replace the cooling fan.</p>
 Over voltage	<p>Decel time is too short compared to the GD^2 of the load.</p> <p>Regenerative load is at the inverter output.</p> <p>Line voltage is too high.</p>	<p>Increase the Decel time.</p> <p>Use Dynamic Brake Unit.</p> <p>Check whether line voltage exceeds its rating.</p>
 Low voltage	<p>Line voltage is low.</p> <p>Load larger than line capacity is connected to line (ex: welding machine, motor with high starting current connected to the commercial line).</p> <p>Faulty magnetic switch at the input side of the inverter.</p>	<p>Check whether line voltage is below its rating.</p> <p>Check the incoming AC line.</p> <p>Adjust the line capacity corresponding to the load.</p>
 Electronic thermal	<p>Motor has overheated.</p> <p>Load is greater than inverter rating.</p> <p>ETH level is set too low.</p> <p>Inverter capacity is incorrectly selected.</p> <p>Inverter has been operated at low speed for too long.</p>	<p>Change a magnetic switch.</p> <p>Reduce load weight and operating duty.</p> <p>Change inverter with higher capacity.</p> <p>Adjust ETH level to an appropriate level.</p> <p>Select correct inverter capacity.</p> <p>Install a cooling fan with a separate power supply.</p>
 External fault A contact input	<p>The terminal set to " 18 (External fault- A) " or " 19 (External fault-B) " in I20-I24 in I/O group is ON.</p>	<p>Eliminate the cause of fault at circuit connected to external fault terminal or cause of external fault input.</p>
 External fault B contact input		
 Operating method when the frequency command is lost	<p>No frequency command is applied to V1 and I.</p>	<p>Check the wiring of V1 and I and frequency reference level.</p>
 Remote keypad communication error	<p>Communication error between inverter keypad and remote keypad.</p>	<p>Check for connection of communication line and connector.</p>
   	<p>- EEP: Parameter save error</p> <p>- HWT: Hardware fault</p> <p>- Err: Communication Error</p> <p>- COM: Keypad error</p>	<p>Contact your LSIS sales distributor.</p>







Safety Instructions

- For your safety, please read user's manual thoroughly before operating.
- Contact the nearest authorized service facility for examination, repair, or adjustment.
- Please contact qualified service technician when you need maintenance. Do not disassemble or repair by yourself!
- Any maintenance and inspection shall be performed by the personnel having expertise concerned.

© 2005.5 LS Industrial Systems Co.,Ltd. All rights reserved.

LS Industrial Systems Co., Ltd.

www.lsis.biz

■ **HEAD OFFICE**

LS Tower 1026-6, Hogue-dong, Dongan-gu,
Anyang-si, Gyeonggi-do 431-848, Korea

- **Europe** +82-2-2034-4376 / ywsohn@lsis.biz
- **Middle East** +82-2-2034-4901 / bonseongk@lsis.biz
- **South West Asia** +82-2-2034-4645 / sungkyup@lsis.biz
- **South East Asia** +82-2-2034-4707 / ohpark@lsis.biz
- **CIS** +82-2-2034-4913 / jinhkang@lsis.biz
- **America** +82-2-2034-4377 / younsupl@lsis.biz

■ **Global Network**

- **LS Industrial Systems (Middle East) FZE** >> **Dubai, U.A.E.**
Address: LOB 19 JAFZA VIEW TOWER Room 205, Jebel Ali Freezone P.O. Box 114216, Dubai, United Arab Emirates
Tel: 971-4-886 5360 Fax: 971-4-886-5361 e-mail: hwym@lsis.biz
- **Dalian LS Industrial Systems Co., Ltd.** >> **Dalian, China**
Address: No.15, Liaohexi 3-Road, Economic and Technical Development zone, Dalian 116600, China
Tel: 86-411-8273-7777 Fax: 86-411-8730-7560 e-mail: lixk@lsis.com.cn
- **LS Industrial Systems (Wuxi) Co., Ltd.** >> **Wuxi, China**
Address: 102-A, National High & New Tech Industrial Development Area, Wuxi, Jiangsu, 214028, P.R.China
Tel: 86-510-8534-6666 Fax: 86-510-522-4078 e-mail: xuhg@lsis.com.cn
- **LS-VINA Industrial Systems Co., Ltd.** >> **Hanoi, Vietnam**
Address: Nguyen Khe - Dong Anh - Ha Noi - Viet Nam
Tel: 84-4-882-0222 Fax: 84-4-882-0220 e-mail: srjo@lsisvina.com
- **LS-VINA Industrial Systems Co., Ltd.** >> **Hochiminh, Vietnam**
Address: 41 Nguyen Thi Minh Khai Str. Yoco Bldg 4th Floor, Hochiminh City, Vietnam
Tel: 84-8-3822-7941 Fax: 84-8-3822-7942 e-mail: sbpark@lsisvina.com
- **LS Industrial Systems Tokyo Office** >> **Tokyo, Japan**
Address: 16FL, Higashi-Kan, Akasaka Twin Tower 17-22, 2-chome, Akasaka, Minato-ku Tokyo 107-8470, Japan
Tel: 81-3-3582-9128 Fax: 81-3-3582-2667 e-mail: jschuna@lsis.biz
- **LS Industrial Systems Shanghai Office** >> **Shanghai, China**
Address: Room E-G, 12th Floor Huamin Empire Plaza, No.726, West Yan'an Road Shanghai 200050, P.R. China
Tel: 86-21-5237-9977 (609) Fax: 89-21-5237-7191 e-mail: jinhk@lsis.com.cn
- **LS Industrial Systems Beijing Office** >> **Beijing, China**
Address: B-Tower 17FL Beijing Global Trade Center B/D. No.36, BeiSanHuanDong-Lu, DongCheng-District, Beijing 100013, P.R. China
Tel: 86-10-5825-6025,7 Fax: 86-10-5825-6026 e-mail: cuixiaorong@lsis.com.cn
- **LS Industrial Systems Guangzhou Office** >> **Guangzhou, China**
Address: Room 1403,14F,New Poly Tower,2 Zhongshan Liu Road,Guangzhou, P.R. China
Tel: 86-20-8326-6764 Fax: 86-20-8326-6267 e-mail: linsz@lsis.biz
- **LS Industrial Systems Chengdu Office** >> **Chengdu, China**
Address: Room 1701 17Floor, huanminhanjun international Building, No1 Fuxing Road Chengdu, 610041, P.R. China
Tel: 86-28-8670-3101 Fax: 86-28-8670-3203 e-mail: yangcf@lsis.com.cn
- **LS Industrial Systems Qingdao Office** >> **Qingdao, China**
Address: 7B40,Haixin Guangchang Sheny Building B, No.9, Shandong Road Qingdao 26600, P.R. China
Tel: 86-532-8501-8568 Fax: 86-532-583-3793 e-mail: lirj@lsis.com.cn



Soluciones
integradas en
Transmisión

E.R.H.S.A.
Girardot 1368 - C1427AKD
C.A. de Buenos Aires - Argentina
Tel. (011) 4554-3232 www.erhsa.com

Specifications in this catalog are subject to change without notice due to continuous product development and improvement.